

## Kee Klamp sistēmas savienojumi

Kee Klamp sistēmas savienojumu izmēri



KEE KLAMP caurules izmērs	Caurules ārējais diametrs (mm)	Caurules iekšējais diametrs (mm)
2	13.5	8
3	17.5	10
4	21.3	15
5	26.9	20
6	33.7	25
7	42.4	32
8	48.3	40
9	60.3	50

3. un 4. lapā tabulu ailē "Tips" pirmie cipari pirms svītriņas norāda Kee Klamp savienojuma **modeli (tipu)**, taču cipari aiz svītriņas norāda **caurules izmēru!**

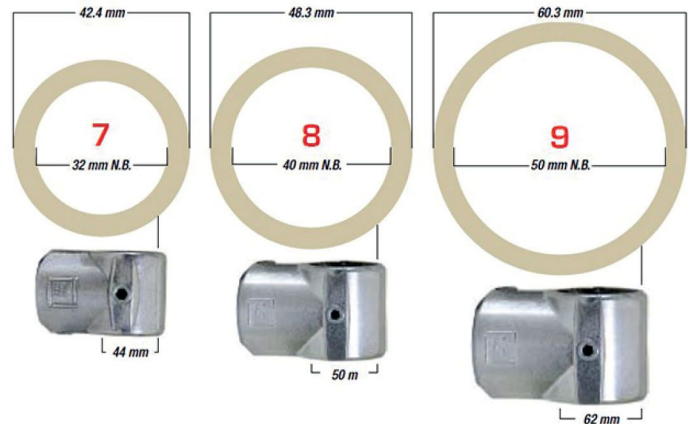
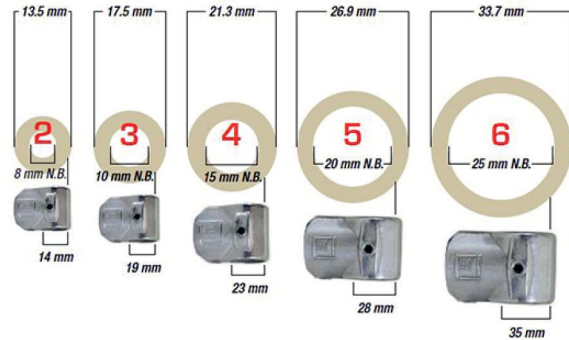





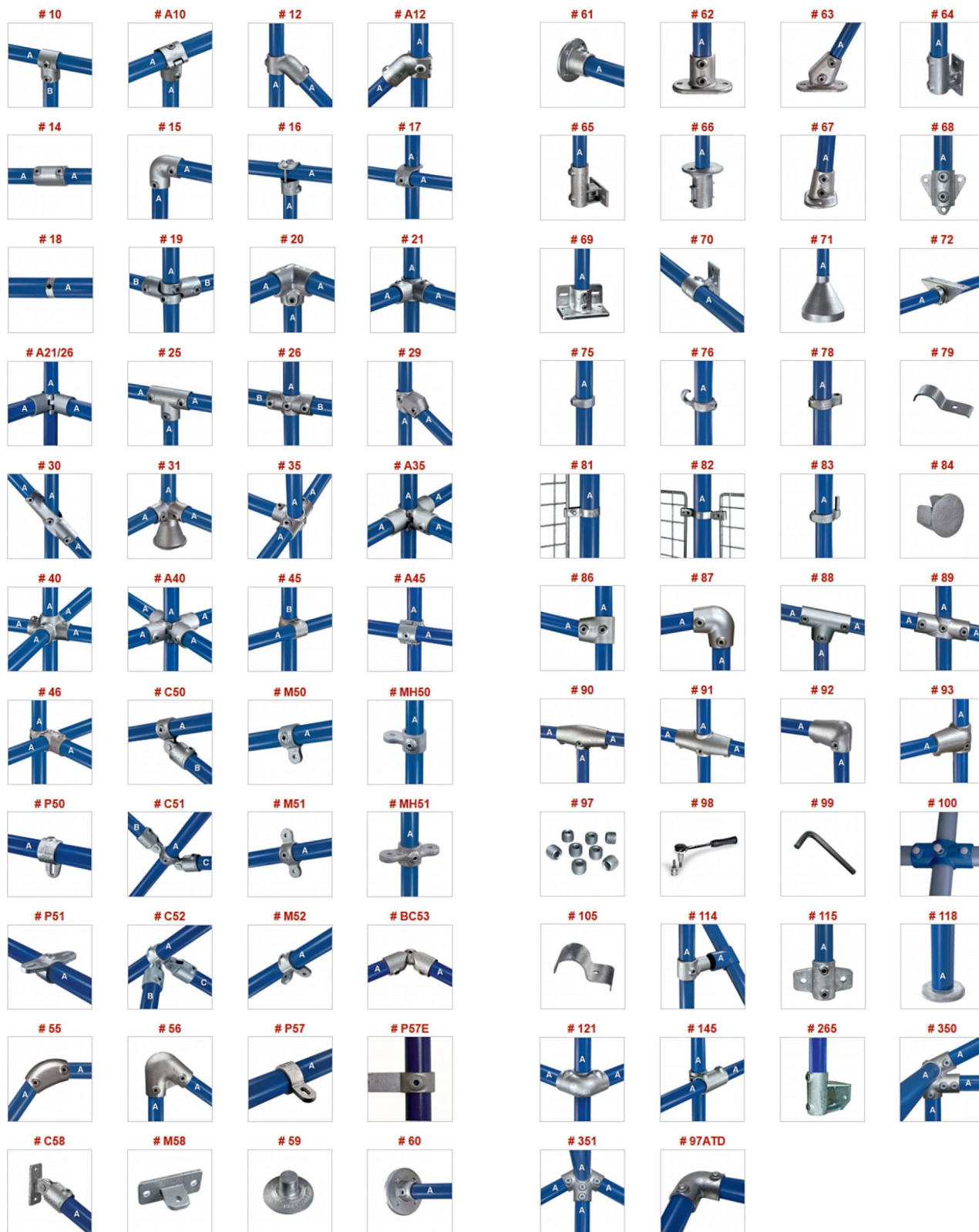













## Kee Klamp sistēmas savienojumi

*Kee Klamp sistēmas savienojumu modeļi (tipi)*

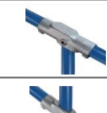
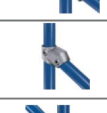

## Kee Klamp sistēmas savienojumi

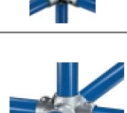
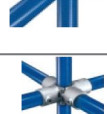
Attēls	Tips
	10-3
	10-4
	10-5
	10-6
	10-65
	10-67
	10-7
	10-75
	10-76
	10-78
	10-8
	10-87
	10-9
10-98	
	A 10-7
	A 10-8
	12-5
	12-6
	12-7
	12-8
	A 12-8
	14-4
	14-5
	14-6
	14-7
	14-8
	14-9
	15-4
	15-5
	15-6
	15-7
	15-8
15-9	
	16-5
	16-6
	16-7
	16-8
	16-9
	17-5
	17-6
	17-7
	17-78
	17-8
	17-9
	17-9
	18-6
	18-7
	18-8
	18-8
	19-5
	19-6
	19-7
	19-8
	19-85
	19-9
	20-4
	20-5
	20-6
	20-7
	20-8
20-9	















Attēls	Tips
	21-4
	21-5
	21-6
	21-7
	21-8
	21-9
	21-9
	A 21-8
	A 26-8
	25-4
	25-5
	25-6
	25-7
	25-8
	25-9
	26-4
	26-5
	26-6
	26-7
	26-8
	26-87
	26-9
	27-6
	27-7
	27-8
	28-6
	28-7
	28-8
	29-6
	29-7
	29-8
	29-9
	30-6
	30-7
	30-8
	31-8
	31-8
	35-4
	35-5
	35-6
	35-7
	35-8
	35-9
	A 35-8
	40-4
	40-5
	40-6
	40-7
	40-8
	40-9
	A 40-8
	45-3
	45-4
	45-5
	45-6
	45-65
	45-7
	45-76
	45-76

























Attēls	Tips
	45-8
	45-86
	45-87
	45-9
	45-98
	45-98
	A 45-7
	A 45-8
	46-4
	46-5
	46-6
	46-7
	46-8
	46-9
	F 50-4
	F50-5
	F 50-6
	F 50-7
	F 50-8
	F 50-9
	M50-4
	M50-5
	M50-6
M50-7	
M50-8	
M50-9	
	MH 50-6
	P 50-8
	C 50-44
	C 50-55
	C 50-66
	C 50-77
	C 50-88
	C 50-99
	M51-5
	M51-6
	M51-7
	M51-8
	M51-9
	MH 51-6
	P 51-8
	C 51-555
	C 51-666
	C 51-777
	C 51-888
	C 51-999

Atkarībā no projekta apjomiem, iespējamas atlaides

## Kee Klamp sistēmas savienojumi

Attēls	Tips
	M52-5
	M52-6
	M52-7
	M52-8
	C 52-555
	C 52-666
	C 52-777
	C 52-888
	BC 53-88
	55-6
	55-7
	55-8
	56-8
	P 57-7
	P 57-8
	P 58-7
	M 58
	C 58-5
	C 58-6
	C 58-7
	C 58-8
	C 58-9
	59-5 <sup>1</sup>
	59-6 <sup>1</sup>
	59-7 <sup>1</sup>
	59-8 <sup>1</sup>
	59-9 <sup>1</sup>
	60-5
	60-6
	60-7
	60-8
	61-3
	61-4
	61-5
	61-6
	61-7
	61-8
	61-9
	62-2 <sup>1</sup>
	62-5
62-6	
62-7	
62-8	
62-9	
	63-6
	63-7
	63-8
	63-8
	64-6
	64-7
	64-8
	65-6

Attēls	Tips
	265-7
	265-8
	66-6
	66-7
	66-8
	67-7
	67-8
	68-6
	68-7
	68-8
	69-6
	69-7
	69-8
	70-5
	70-6
	70-7
	70-8
	71-6
	71-7
	71-8
	72-8
	75-4
	75-5
	75-6
	75-7
	75-8
	76-5
	76-6
76-7	
	76-8
	77-4 <sup>2</sup>
	77-5 <sup>2</sup>
	77-6 <sup>2</sup>
	77-7 <sup>2</sup>
	77-8 <sup>2</sup>
	77-9 <sup>2</sup>
	78-5
	78-6
78-7	
78-8	
	79-7
	81-5
	81-6
	81-7
	81-8
	81-9
	82-5
	82-6
	82-7
	82-8
	82-9
	83-5
	83-6
	83-7
	83-8

Attēls	Tips
	84-5
	84-6
	84-7
	84-8
	84-9
	86-8
	87-7
	87-8
	88-7
	88-8
	89-7
	89-8
	90-8
	91-8
	92-8
	93-8
	95-8
	105-6
	105-7
	105-8
	105-9
	114-2 <sup>1</sup>
	114-6
	114-7
	114-8
	114-8
	115-6
	115-7
	115-8
	S 115
	118-8
	121-7
	145-7
	350-8
	351-8
	97-2,3
	97-4
	97-5,6
	97-7,8,9
	Cepurītes
	100-5,6 <sup>2</sup>
	100-7,8,9 <sup>2</sup>
	98-Set
	E-98-5,6
	E-98-7,8,9
	99-2,3
	99-4
	99-5,6
	99-7,8,9

Atšifrējumi norādēm: 1 - alumīnijs 2 - plastmasa Z - cena pēc pieprasījuma

Atkarībā no projekta apjomiem, iespējamas atlaides